

User Manual-Smart Cylinder

TUYA BLE VERSION



Smart your life!
Version 1.0 Edition D1

1 Packing Accessories

Please check the packing box and accessories when you got the item in hand.



Smart Lock

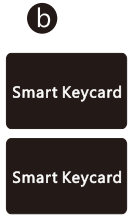

Epoxy Card

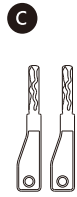

Manual Key



Sucker



Tool



Manual

2 Product Specification

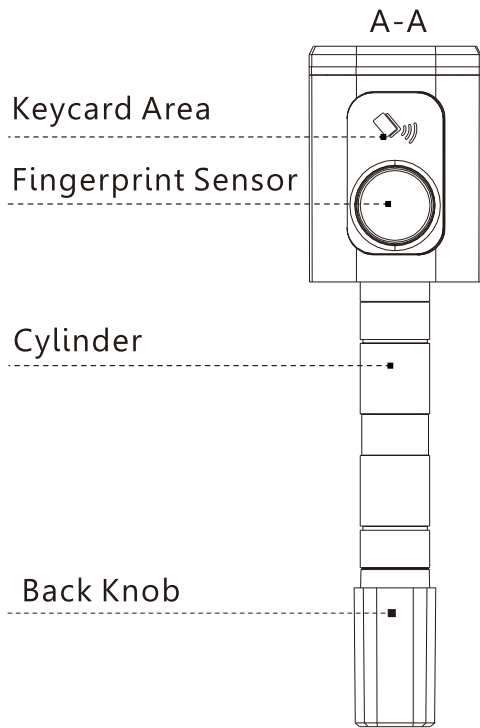

1

3 Reader View

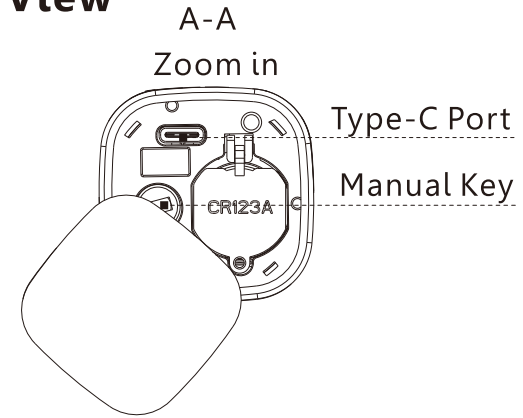

4 Dimension

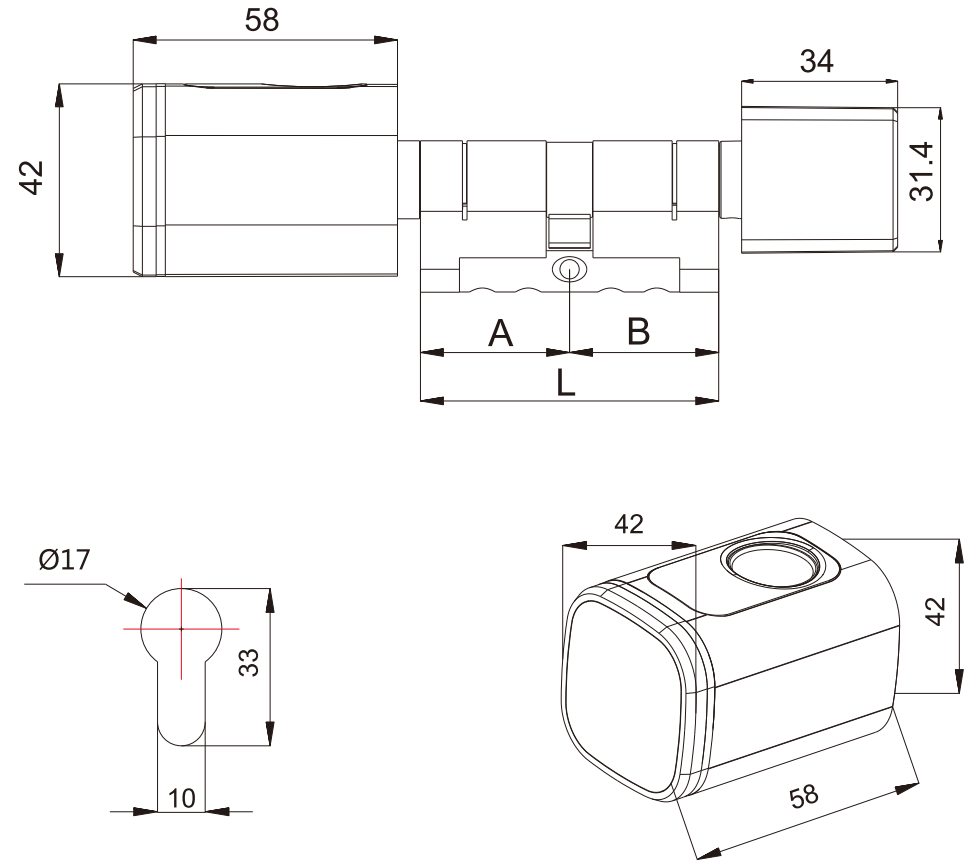

2

5 INSTALLATION STEPS

5.1 Please use the screw driver to take off the screw on the back knob position, refer the below Pic.1:

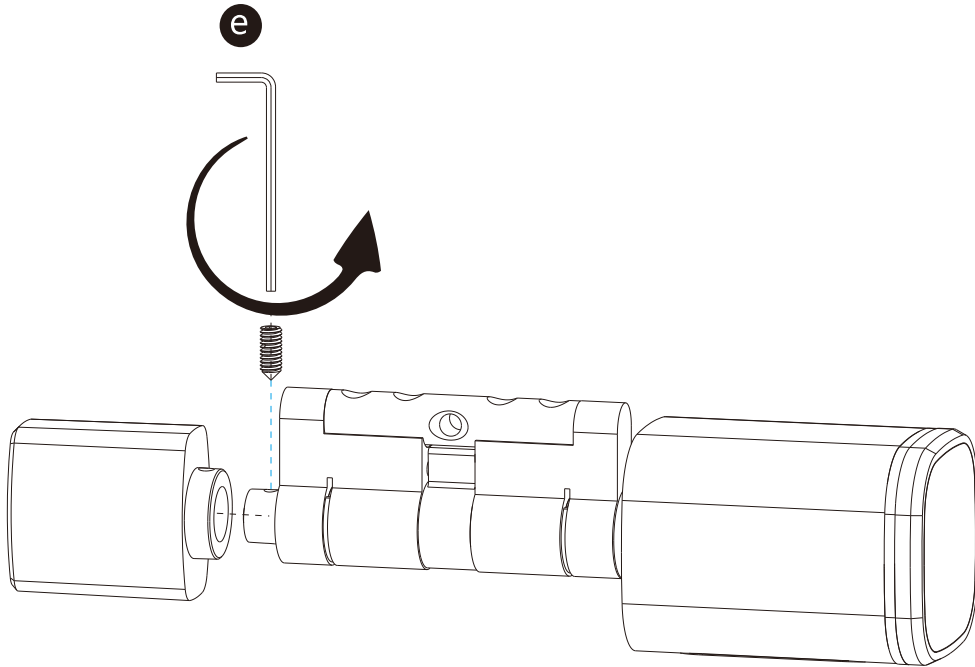

Pic.1

5.2 Please insert the cylinder to the existed lock and fix the cylinder with the long screw as picture 2.

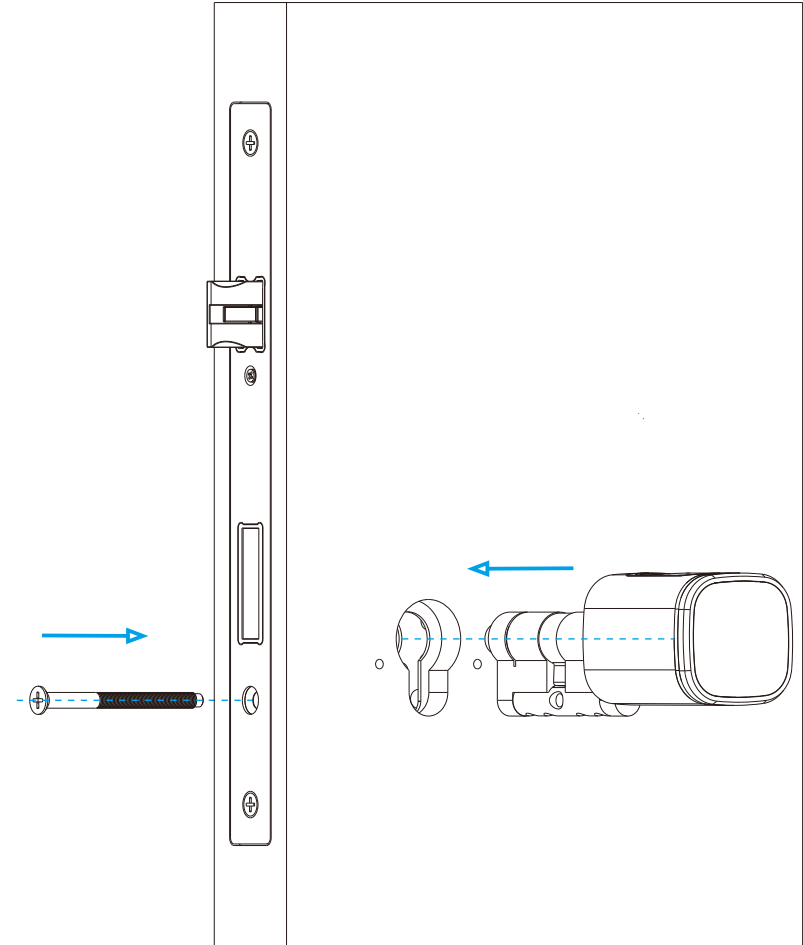

Pic.2

5.3 Please use the screw driver to fasten the screw on the back knob position, refer the below picture 3:

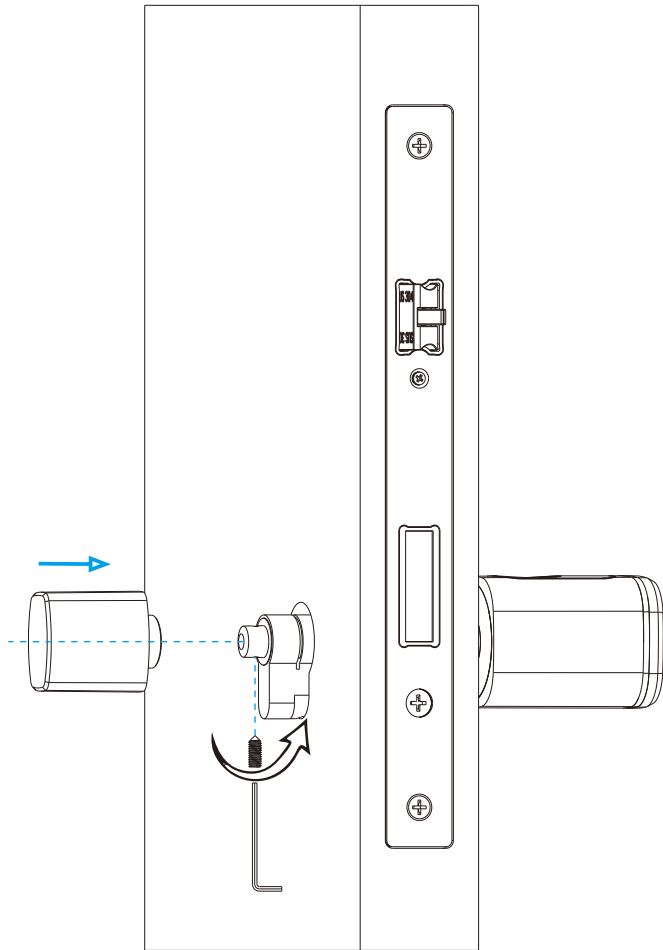

Pic.3

5.4 Please take off the reader cover with the magnet or sucker (included in our accessories bag), assemble 1xCR123a alkaline battery, refer the below picture 4:

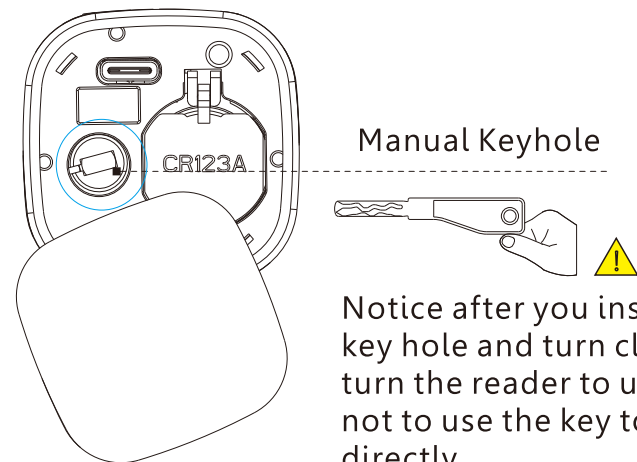
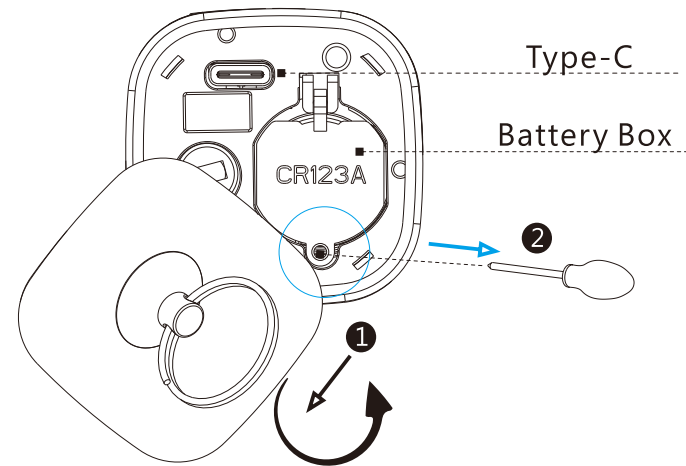

Notice after you insert the key into the key hole and turn clockwise, you shall turn the reader to unlock the door but not to use the key to unlock the door directly.

Pic.4

5.5 Please test with your fingerprint under the factory state, any fingerprint will unlock the door lock, refer the below picture 5:

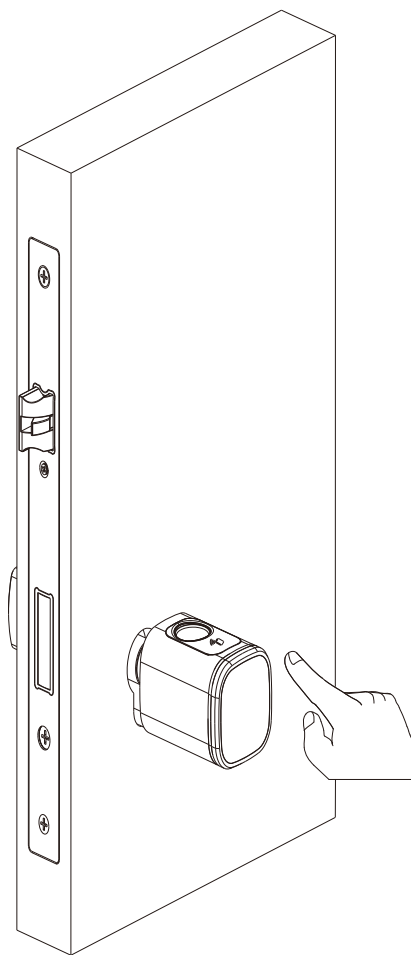

Pic.5

5.6 Please test the lock with key card after you configure the lock with Tuya smart APP(Refer the Part 6).

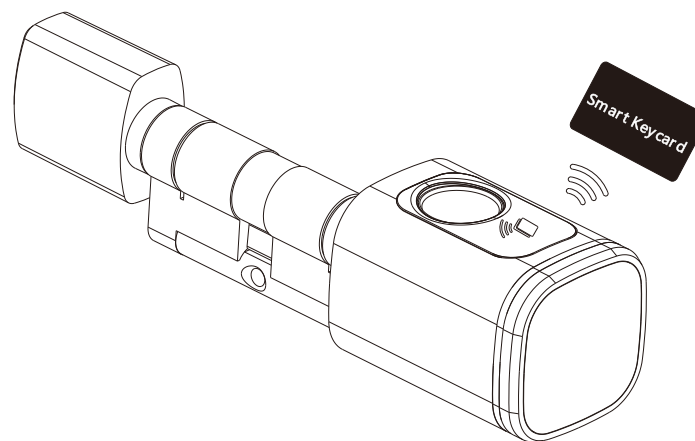

Notice the keycard or fingerprint can only be enrolled by the Tuya smart APP, so it is important to install this app in your mobile before start daily use.

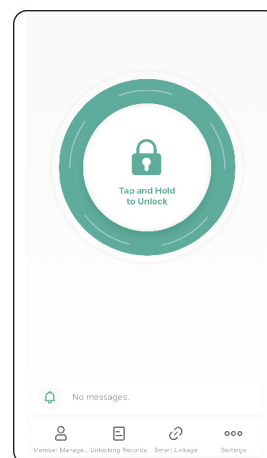

6. Tuya APP Settings

Please download the Tuya smart or Smart life on Apple store or Google play. also you can scan the QR code below to download the APP directly.

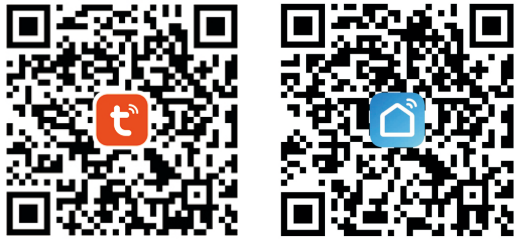

6.1 Please register one account with your E-mail or mobile number.

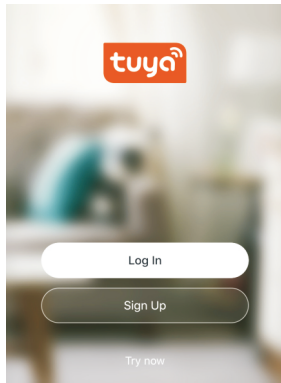

6.1.1 Sign Up

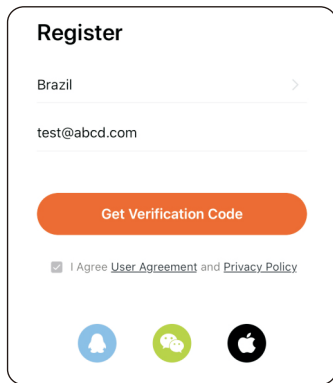

6.1.2 Enter mobile or mail
Get Verification Code

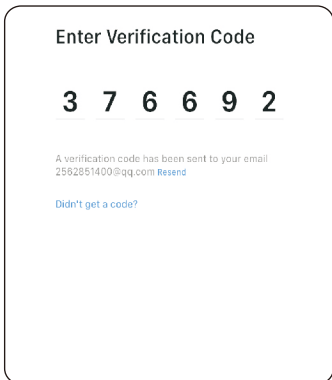

6.1.3 Enter the code sent
to your mail or mobile

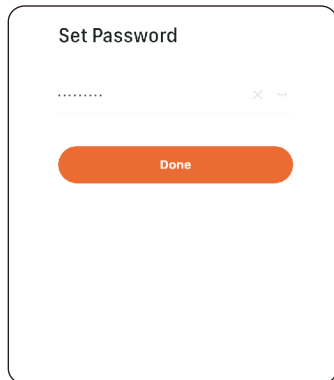

6.1.4 Set password and login

6.2 Intelligent Configuration

Please run the Tuya smart APP and click "Add Device" on the right top position for auto scan:

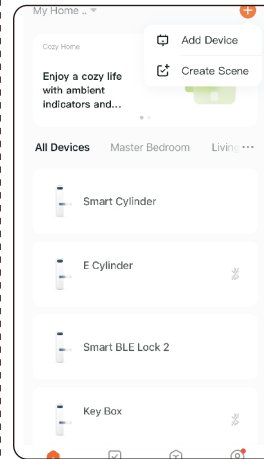

Step 1
Add Device

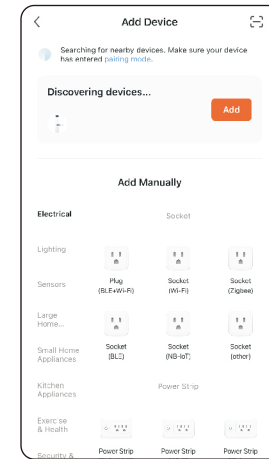

Step 2
Activate the lock
Click "Add"

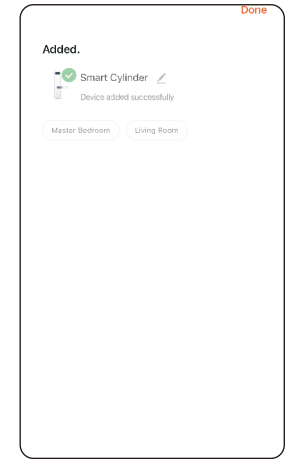

Step 3
Done

6.3 Function Description

Under Tuya smart APP interface, you can see the features for the smart locks, such as Member /unlock records and settings etc.

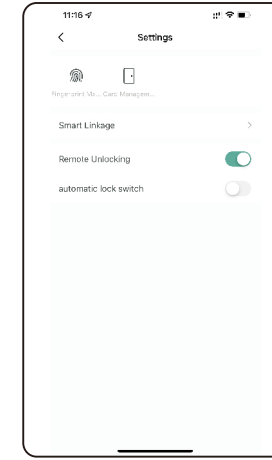
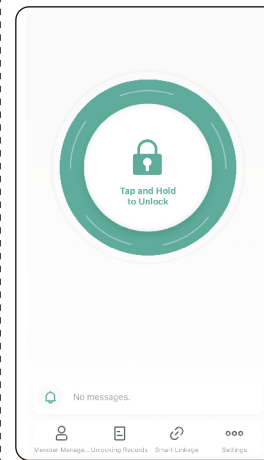

6.4 Add User Fingerprint

Under Tuya smart APP setting, you can click the fingerprint management and add the fingerprint.

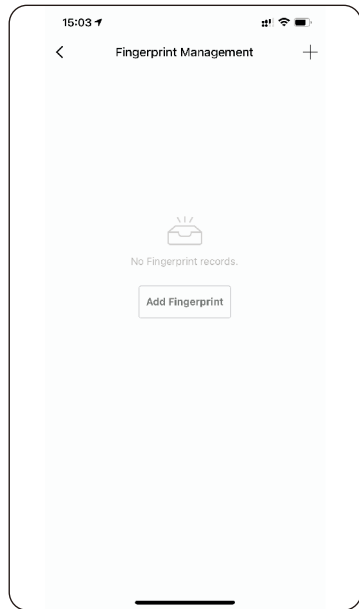

Step1:
Click Add Fingerprint

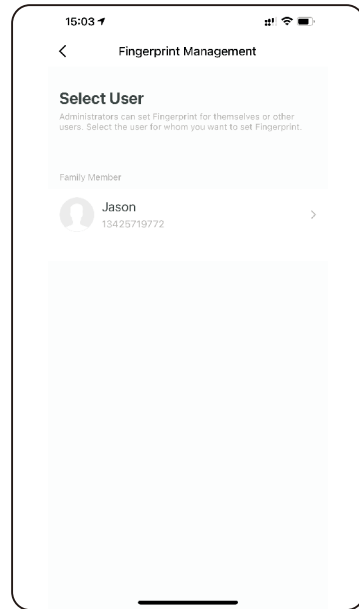

Step2 Select User

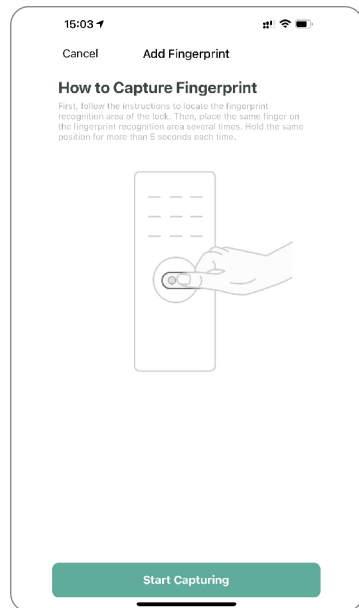

Step3:
Start Capturing

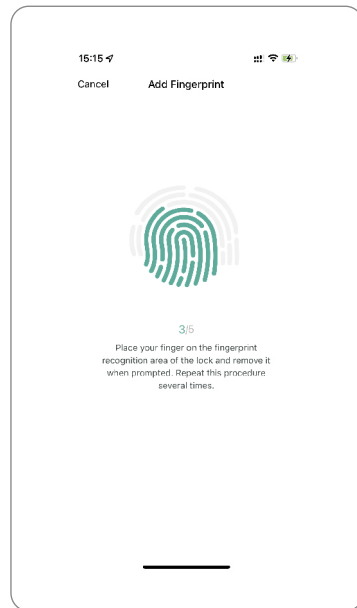

Step 4:
5 Times and done

6.5 Add User Card

Under Tuya smart APP setting, you can click the card Management and add the card.

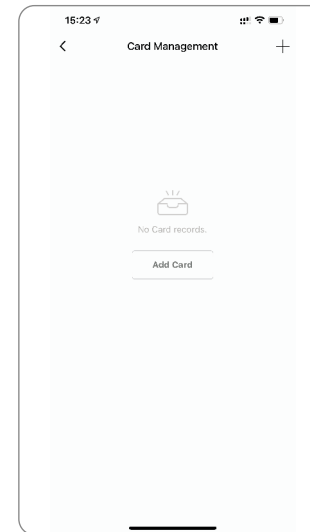

Step1:
Click Add Card

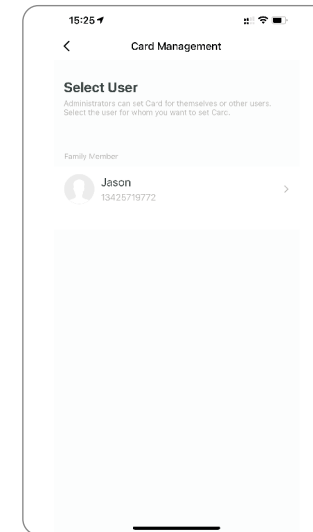

Step2:
Select User

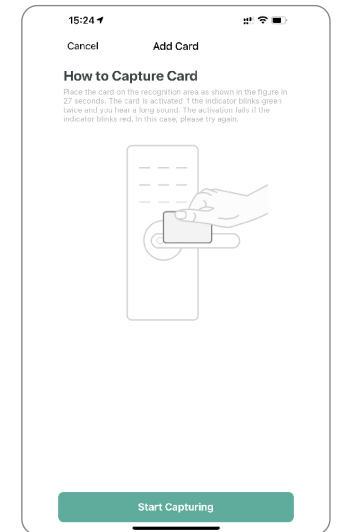

Step3:
Tap Card on the lock
induction area

6.7 Smart Linkage and Settings

Under the settings, you can click the smart linkage for more scene and more options for the features upon the using condition.

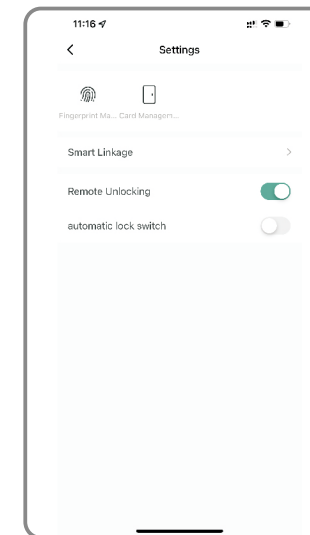
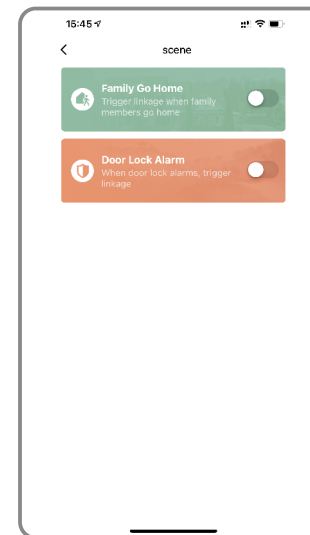

6.8 Passage Mode

Under Tuya smart APP setting, you can tick "automatic lock switch", under this setting the lock will be in always open state, you can press any valid fingerprint to cancel this passage mode.

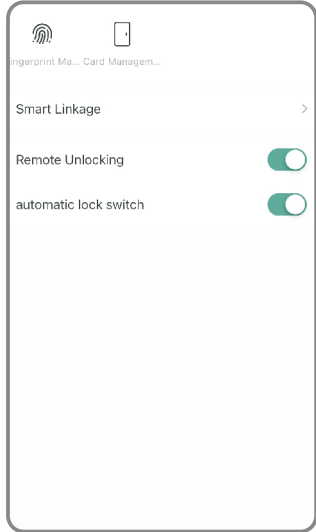

7. Reset the Lock

Under Tuya smart APP setting, you can click the "Remove Device" to reset the lock and the lock will be set to factory state, you can use any fingerprint to unlock the lock.

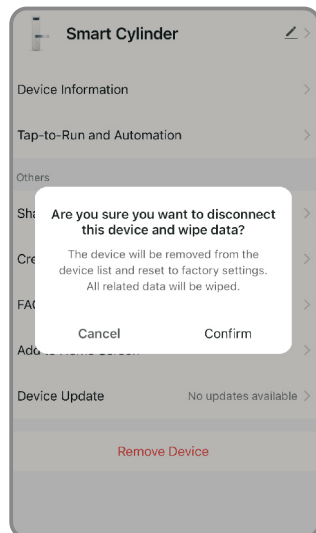

8. Sales and Service Terms

- Please read the manual carefully before use!
- Limited 1-year Electronic Warranty Limited Lifetime Mechanical and Finish Warranty
- This D1 product comes with a 1-year Limited Warranty on Electronic Parts and a Limited lifetime. Mechanical and Finish Warranty against defects in materials and workmanship under normal use to the original residential user. Proof of purchase and ownership is required for the warranty to be in effect.
- Any error or question in our manual or sales term, please feel free to contact with us.
- For any wrong operation or installation to the user, we do not responsible for the duty.
- For the damage caused by anthropic factor or inevitable reason, we do not pay for the loss or maintain for free, please check our after sale service terms.
- Please do not take apart the lock if you are not technician, if necessary, please make the operations under the guide of technician.
- Notice: there maybe a little difference for product pictures with real product, please subject to our real products.